

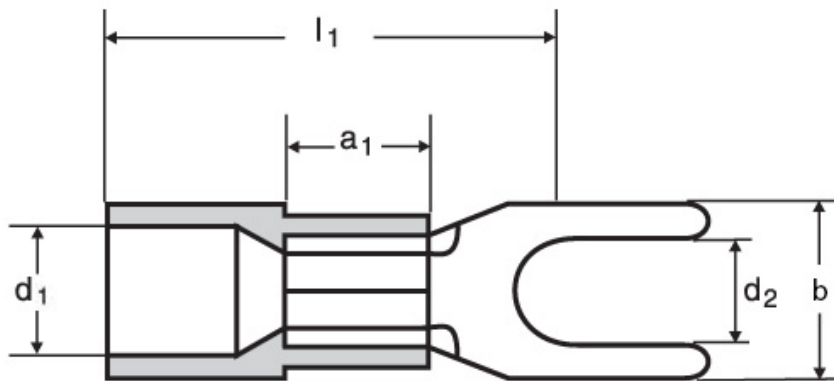

Gabelkabelschuh, isoliert, blau

1,5 - 2,5 mm², easy entry



Art. Nr.	Werkstoff	Isolation		
IG-2,5-5	Cu-ETP, gal Sn	PA transp.	1,10/1000	100

	d1	d2	b	
in mm:	4.6	5.3	10	

	l1	a1	s	
in mm:	20	5	0.8	