

Gabelkabelschuh, isoliert, blau

1,5 - 2,5 mm², easy entry

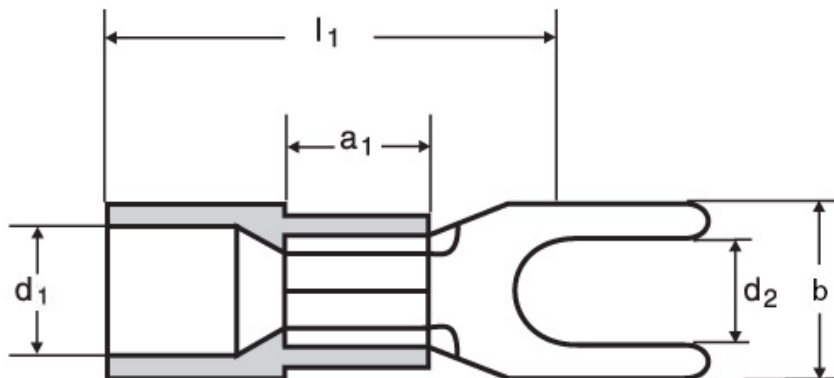
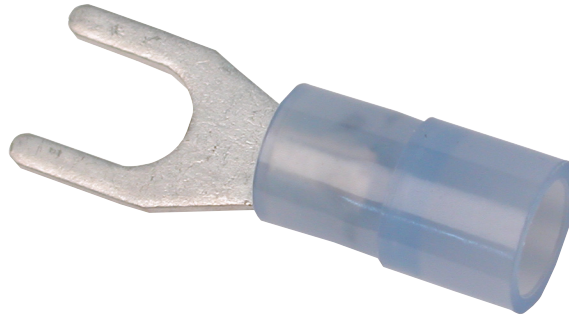

Art. Nr.	Werkstoff	Isolation		
IG-2,5-6	Cu-ETP, gal Sn	PA transp.	1,20/1000	100

	d1	d2	b	
in mm:	4.6	6.4	12	

	l1	a1	s	
in mm:	23	5	0.8	